

KN20+

Category II or Category IV Appliance
(see Installation and Operation Manual for venting information)

CODE OPTIONS

CSD-1	STANDARD
-------	----------

INDOOR UNIT

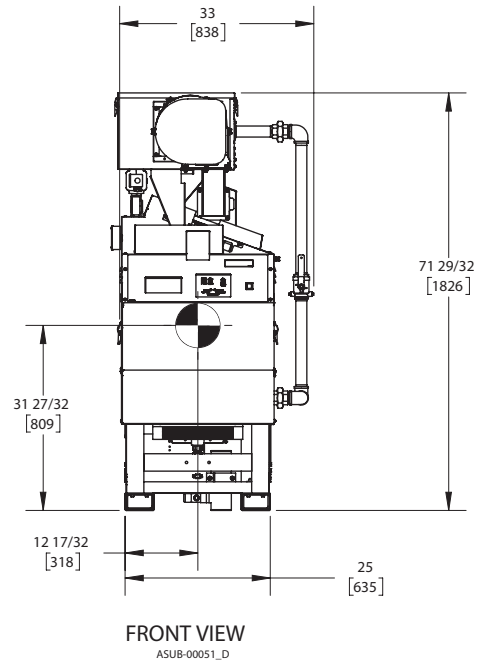
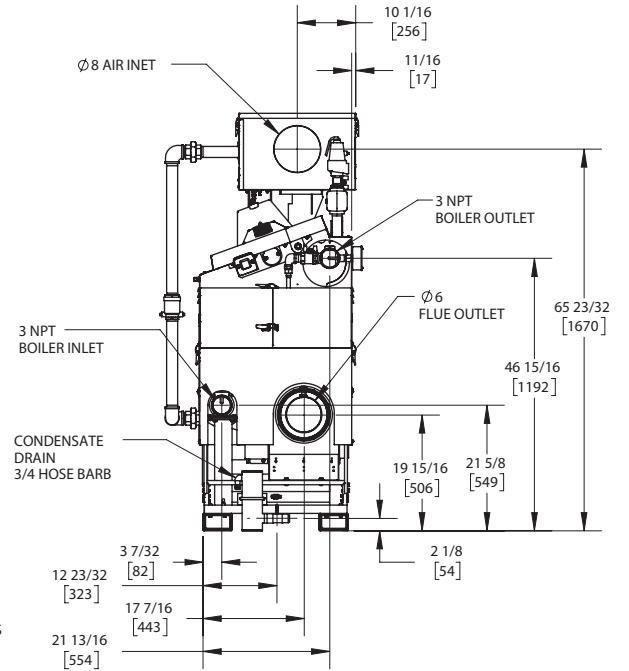
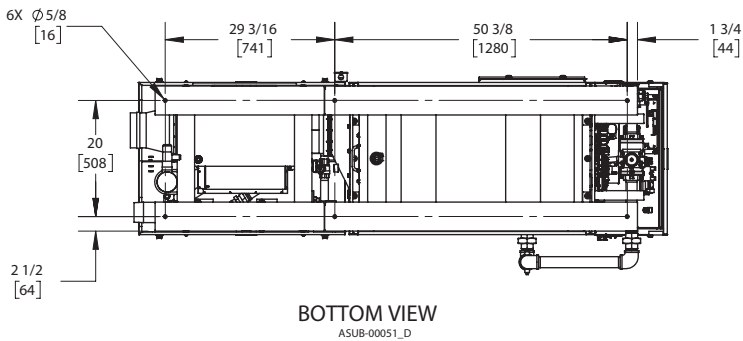
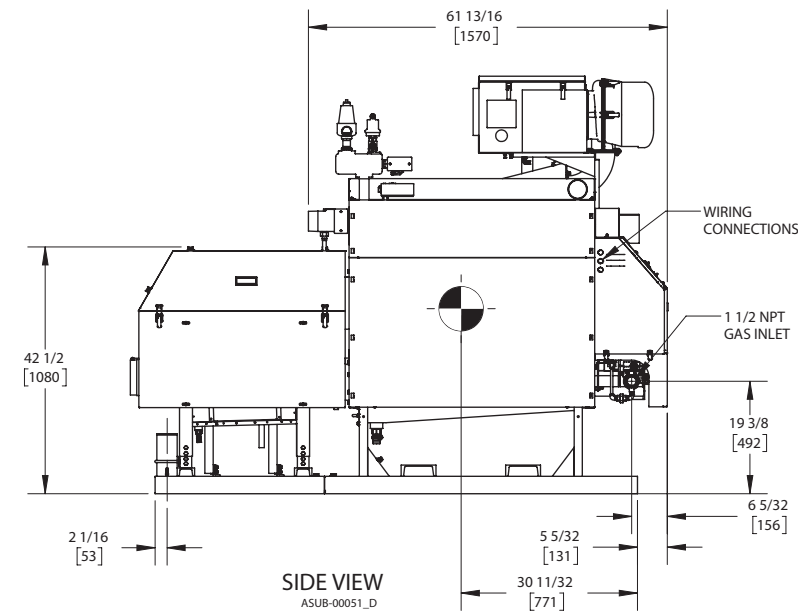
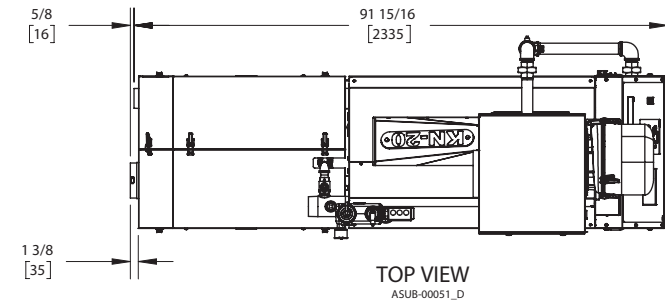

NOTES:

1. SYMBOL INDICATES CENTER OF GRAVITY.
2. DIMENSIONS ARE NOMINAL AND SUBJECT TO MANUFACTURING VARIATION AND SHOULD NOT BE USED FOR "ROUGHING IN".
3. ALL DIMENSIONS ARE INCHES [mm].



A.G.A. CERTIFIED RATINGS & CAPACITIES

Fuel Type	Natural/LP Gas	Boiler FLA	13.9 A*
Input BTU/hr.	2,000,000 / 586 KW	Min. Gas Pressure Required	3" W.C.
Output BTU/hr.	1,904,000 / 558 KW	Max. Gas Pressure Allowed	14" W.C.
Boiler HP	56.9	Water Volume	24.9 gal.
Electrical Requirements	230VAC/60 hz/1PH (with neutral)	Operating Weight	3040 lbs. / 1379 kg.
SCCR Rating	5kA		

BOILER TRIM & CONTROLS

Main Gas Valve	Dungs MBC	Air Switch	Huba
Firing Valve	1-1/2" Apollo	Flow Sensor	SIKA
Ignition Control	Honeywell RM7895C	Blocked Flue Switch	Cleveland NS2
Operating Control	HeatNet®	Blower Motor	Ametek
High Limit	Honeywell L4006E	L.W.C.O.	800
Main Ball Valve	1-1/2" Apollo	Relief Valve	30, 50, 75 & 100 PSI
Pilot Cock	1/4" Conbraco	Pilot Regulator	Maxitrol RV12LT

A.S.M.E.

ASME Sect IV Fire Side Htg Surface	446.7 Sq. Ft. / 41.5 Sq. M.	Design Data	100 PSI & 250°F
ASME Sect IV Water Side Htg Surface	87.13 Sq. Ft. / 8.09 Sq. M.		
CV. GPM (1PSID)	161		

*Add circulator amps.

TEMPERATURE RISE / PRESSURE DROP (Based on Full Input)

20°F / 11.1°C				40°F / 22.2°C				60°F / 33.3°C				80°F / 44.4°C				100°F / 55.5°C			
Flow Rate		Pressure Drop		Flow Rate		Pressure Drop		Flow Rate		Pressure Drop		Flow Rate		Pressure Drop		Flow Rate		Pressure Drop	
GPM	L/s	Ft	kPa	GPM	L/s	Ft	kPa	GPM	L/s	Ft	kPa	GPM	L/s	Ft	kPa	GPM	L/s	Ft	kPa
190.5	12.02	3.23	9.65	95.2	6.01	.81	2.41	63.5	4.01	.36	1.07	47.6	3.00	.20	.60	38.1	2.40	.13	.39

Flow GPM		Temp. Rise** (°F)		Vent Length (Equiv. Ft.)		Air Inlet Length (Equiv. Ft.)	
Min	Max	Min	Max	Min	Max	Min	Max
38.1	190.5	20	100	6	100	0	100

**Min/Max delta t reflects boiler operation at full input. For applications requiring operation above/below these parameters please consult factory.

REP FIRM	_____
SUBMITTED BY	_____
JOB NAME	_____
ARCHITECT	_____
ENGINEER	_____
CONTRACTOR	_____
DATE	_____

KN20+

Category II or Category IV Appliance
(see Installation and Operation Manual for venting information)



A Division of Mestek, Inc.
Westfield, MA 01085
(413) 564-5515